

FURUNO

OPERATOR'S MANUAL

MARINE RADAR

MODEL MODEL 1622



FURUNO ELECTRIC CO., LTD.
NISHINOMIYA, JAPAN

PRINTED IN JAPAN

© **FURUNO ELECTRIC CO., LTD.**

9-52, Ashihara-cho,
Nishinomiya, Japan

Telephone: 0798-65-2111
Telefax: 0798-65-4200

•Your Local Agent/Dealer

All rights reserved. Printed in Japan

FIRST EDITION : JUN. 1999
J2 : OCT. 7, 2002

(DAMI) PUB. No. OME-34520
MODEL1622



* 00080875400 *



* OME34520J20 *

SAFETY INSTRUCTIONS

WARNING



ELECTRICAL SHOCK HAZARD
Do not open the equipment.

Only qualified personnel should work inside the equipment.



Turn off the radar power switch before servicing the antenna unit. Post a warning sign near the switch indicating it should not be turned on while the antenna unit is being serviced.

Prevent the potential risk of being struck by the rotating antenna and exposure to RF radiation hazard.



Wear a safety belt and hard hat when working on the antenna unit.

Serious injury or death can result if someone falls from the radar antenna mast.

Do not disassemble or modify the equipment.

Fire, electrical shock or serious injury can result.

Turn off the power immediately if water leaks into the equipment or the equipment is emitting smoke or fire.

Continued use of the equipment can cause fire or electrical shock.

WARNING

Use the proper fuse.

Fuse rating is shown on the equipment. Use of a wrong fuse can result in equipment damage.

Keep heater away from equipment.

Heat can alter equipment shape and melt the power cord, which can cause fire or electrical shock.

The useable temperature ranges are

Antenna unit: -25°C to +70°C
Display unit: -15°C to +55°C

CAUTION

WARNING LABEL

The warning label shown below is attached to the display unit. Do not remove this label. If the label is peeling off or is illegible, contact FURUNO for replacement.

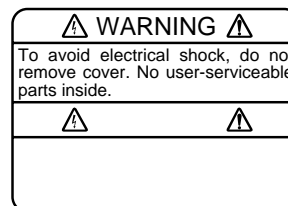

Name: Warning Label (1)
Type: 86-003-1011-0
Code No.: 100-236-230

TABLE OF CONTENTS

INTRODUCTION	iii
SYSTEM CONFIGURATION	iv
PRINCIPLE OF OPERATION	v
1. OPERATION.....	1
1.1 Control Description.....	1
1.2 Indications and Markers	2
1.3 Turning the Radar On/Off	3
1.4 Transmitting, Stand-by	3
1.5 LCD Tone and Brilliance	3
1.6 Selecting the Range	3
1.7 Receiver Sensitivity	4
1.8 Suppressing Sea Clutter.....	4
1.9 Suppressing Rain Clutter.....	5
1.10 Range Rings	5
1.11 Cursor.....	5
1.12 Heading Marker.....	6
1.13 Menu Operation.....	6
1.14 Control Panel Brilliance	7
1.15 Measuring the Range	7
1.16 Measuring the Bearing	8
1.17 Shifting the Display.....	8
1.18 Zoom.....	8
1.19 Target Trails.....	9
1.20 Guard Alarm Zone.....	9
1.21 Interference Rejector.....	10
1.22 Echo Stretch.....	11
1.23 Watchman	11
1.24 Navigation Data.....	12
1.25 Displaying Navigation Data During Stand-by	12
1.26 Echoes in Black or White.....	13
1.27 Selecting Ranges to Use	13
2. RADAR OBSERVATION	15
2.1 General	15
2.2 False Echoes	16
2.3 SART (Search and Rescue Transponder)	17
2.4 Racon (Radar Beacon).....	19
3. MAINTENANCE, TROUBLESHOOTING	21
3.1 Maintenance.....	21
3.2 Replacing the Fuse	21
3.3 Troubleshooting.....	22
3.4 Magnetron Replacement.....	22
3.5 Synchro Belt Replacement	22
SPECIFICATIONS	SP-1
INDEX.....	Index-1

Declaration of Conformity

INTRODUCTION

A Word to FURUNO Model 1622 Owners

FURUNO Electric Company thanks you for purchasing the MODEL 1622 Marine Radar. We are confident you will discover why the FURUNO name has become synonymous with quality and reliability.

For over 50 years FURUNO Electric Company has enjoyed an enviable reputation for quality and reliability throughout the world. This dedication to excellence is furthered by our extensive global network of agents and dealers.

Your radar is designed and constructed to meet the rigorous demands of the marine environment. However, no machine can perform its intended function unless properly installed and maintained. Please carefully read and follow the installation, operation and maintenance procedures set forth in this manual.

We would appreciate feedback from you, the end-user, about whether we are achieving our purposes.

Thank you for considering and purchasing FURUNO.

Features

Your radar has a large variety of functions, all contained in a rugged plastic case. All controls respond immediately to the operator's command and each time a key is pressed the corresponding change can be seen on the screen.

The main features of the MODEL 1622 are

- Daylight viewing radar specially designed for small craft and sailing yachts.
- Traditional FURUNO reliability and quality in a compact, light-weight and low-cost radar.
- Compact and light-weight radome antenna with precision 34 cm center-fed radiator.
- Stepping scanner motor.
- High definition 6-inch LCD display.

- Automatic control of sensitivity and STC for simplified operation.
- Targets can be displayed in black on white background or vice versa, for optimal viewing under any lighting.
- On-screen alphanumeric readout of all operational information.
- Standard features include Display Shift, EBL, Echo Stretch, Target Trail, Guard Alarm, Interference Rejector, VRM, Zoom.
- Guard zone watches for targets entering (or exiting) a guard zone.
- Operates on 12V or 24V power and consumes approx. 35 watts power.
- Position in latitude and longitude, speed, and range and bearing to a waypoint can be shown in the bottom text area. (Requires navigation data input in NMEA 0183 format.)
- Navigation data such as position, water temperature and depth can be shown during stand-by. (Requires appropriate sensors.)
- LCD equipped with temperature sensor with maintains viewability under temperature change.
- Can be connected to Radar Remote Display FMD-1712.



SYSTEM CONFIGURATION

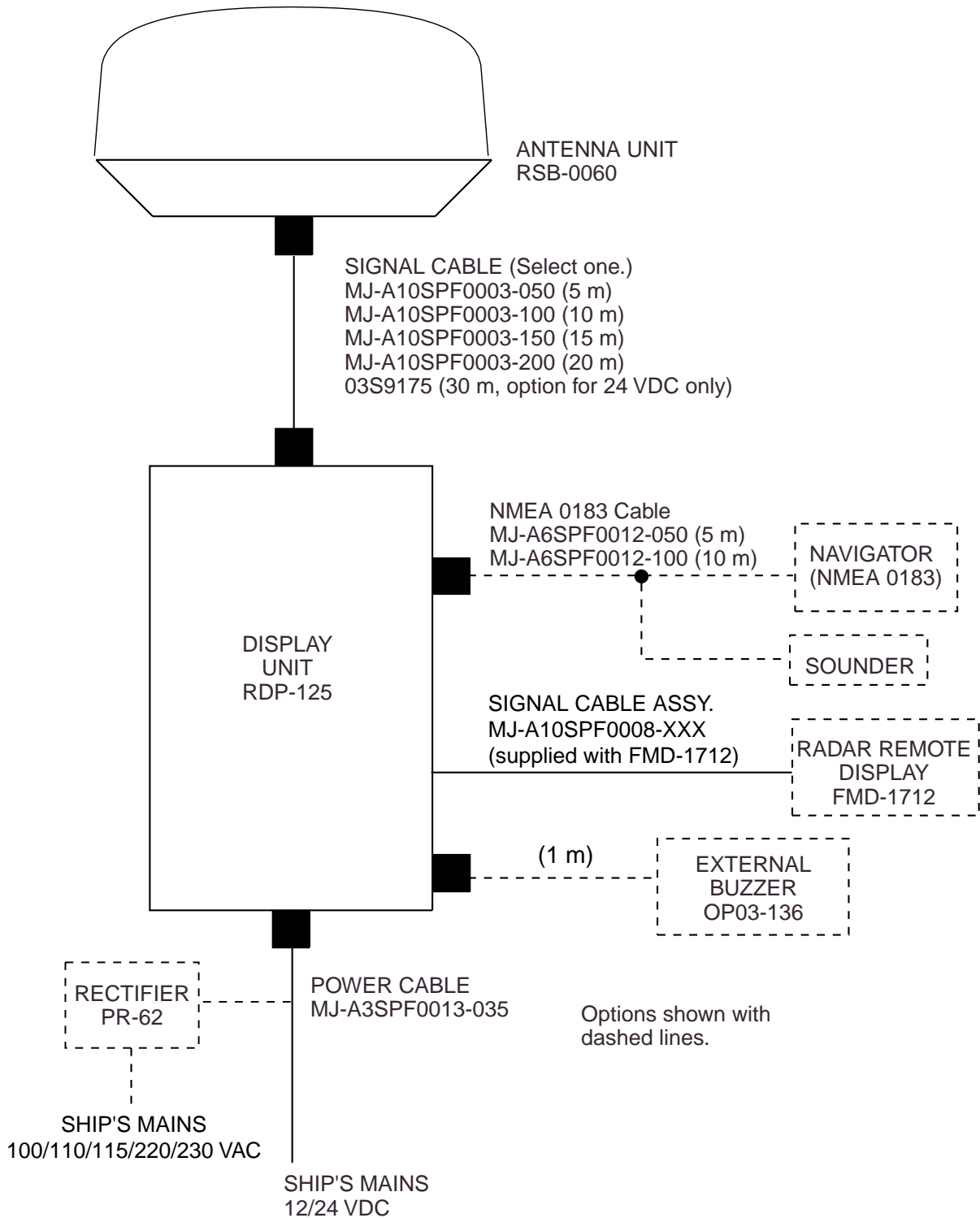

PRINCIPLE OF OPERATION

What is Radar?

The term RADAR is an acronym meaning RAdio Detection and Ranging. It is a device which measures the time it takes for a pulsed signal to be reflected back from an object.

How Ships Determined Position Before Radar

The use of echoes to determine position did not begin with radar. Ships would sound a short blast on their whistles, fire a shot, or strike a bell as an aid to navigation when running in fog near a rugged shoreline. The time between the origination of the sound and the returning of the echo indicated how far the ship was from the cliffs or the shore. The direction from which the echo was heard indicated the relative bearing of the shore.

How Radar Determines Range

Radar determines the range to the target by calculating the time difference between the transmission of a radar signal and the reception of the reflected echo. It is a known fact that radar waves travel at a nearly constant speed of 162,000 nautical miles per second. Therefore the time required for a transmitted signal to travel to the target and return as an echo to the source is a measure of the range to the target. Note that the echo makes a complete round trip, but only half the time of travel is needed to determine the one-way range to the target. This radar automatically takes this into account in making the range calculation.

How Radar Determines Bearing

The bearing to a target found by the radar is determined by the direction in which the radar antenna is pointing when it emits an electronic pulse and then receives a returning echo. Each time the antenna rotates pulses are transmitted in the full 360 degree circle, each pulse at a slightly different bearing from the previous one.

Therefore, if one knows the direction in which the signal is sent out, one knows the direction from which the echo must return.

Radar Wave Speed and Antenna Rotation Speed

The speed of the radar waves out to the target and back again as echoes is extremely fast compared to the speed of rotation of the antenna. By the time radar echoes have returned to the antenna, the amount of antenna rotation after initial transmission of the radar pulse is extremely small.

The Radar Display

Targets are displayed on what is called a Plane Position Indicator (PPI). This display is essentially a polar diagram, with the transmitting ship's position at the center. Images of target echoes are received and displayed at their relative bearings, and at their distance from the PPI center.

With a continuous display of the images of targets, the motion of targets is also displayed.

See the figure on the next page for a comparison of actual situation and radar picture.

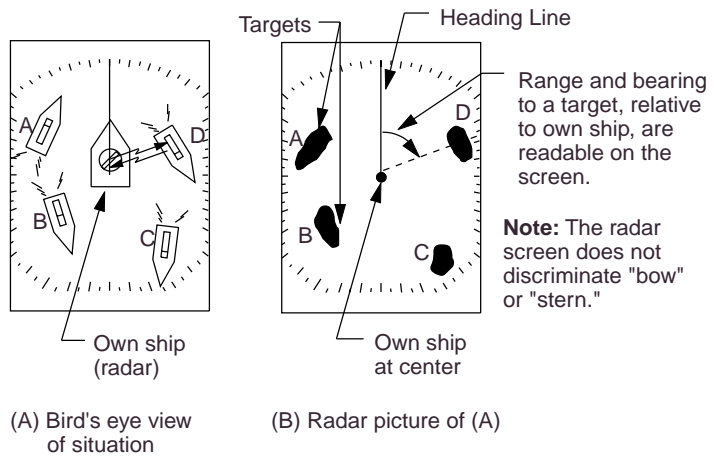

1. OPERATION

1.1 Control Description

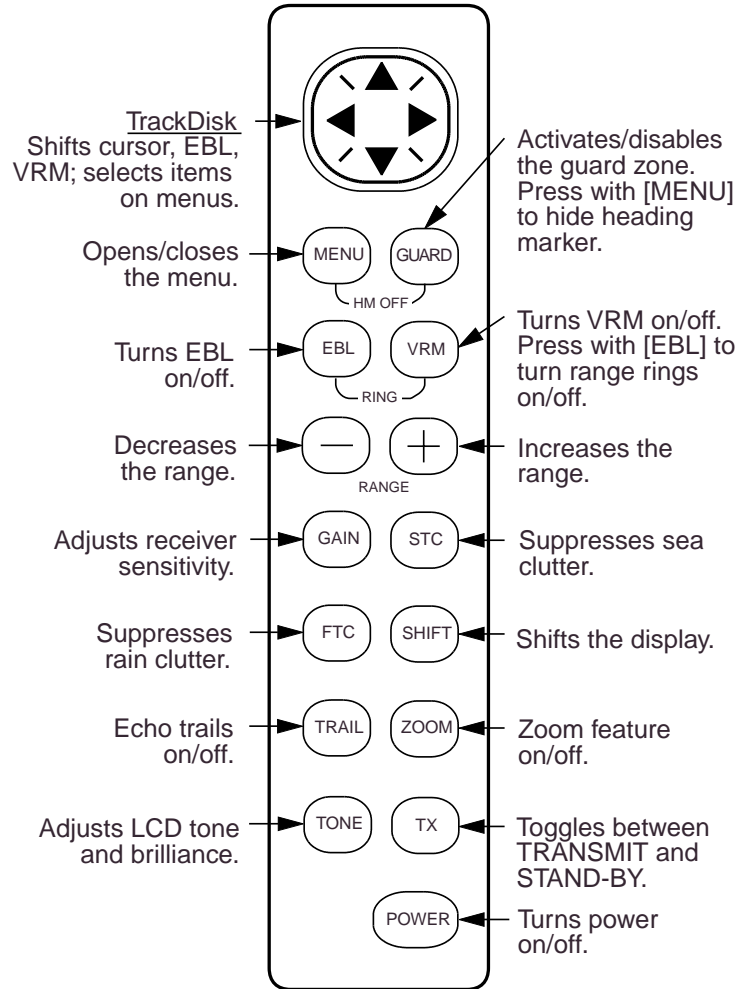

Figure 1-1 Controls

1.2 Indications and Markers

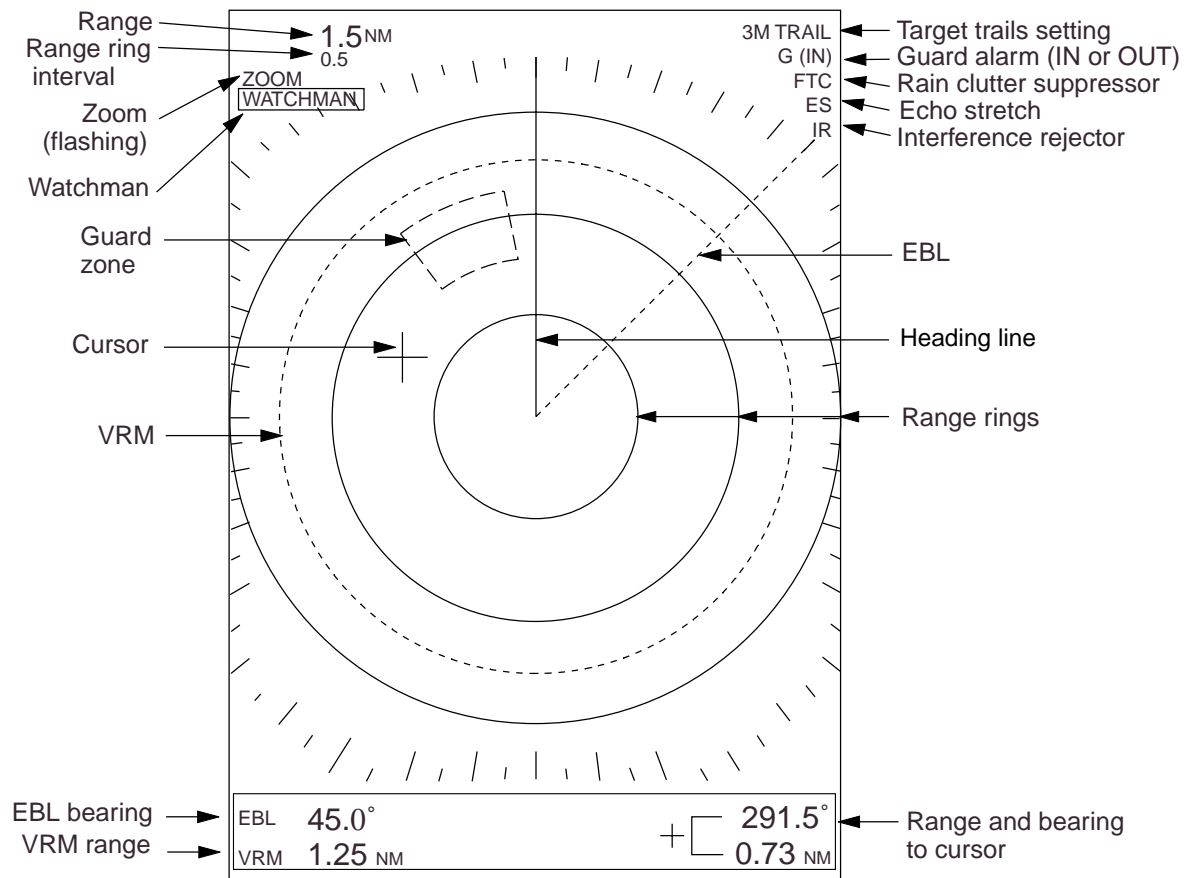

Figure 1-2 Indications and markers

1.3 Turning the Radar On/Off

The [POWER] key turns the radar on/off. When turning on the power, the control panel lights and the timer displays the time remaining for warm up of the magnetron (device which transmits radar pulses), counting down from 1:00 to 0:00.

Quick Start

Provided that the radar was once in use with the transmitter tube (magnetron) still warm, you can turn on the radar into TRANSMIT status without the one-minute stand-by. If the power switch has been turned off by mistake and you want to restart the radar promptly do the following:

1. Press the [POWER] key not later than five seconds after power-off.
2. Press the [TX] key. The radar is restored for full operation.

1.4 Transmitting, Stand-by

After the power is turned on and the magnetron has warmed up, ST-BY (Stand-By) appears at the screen center, indicating the radar is ready to transmit radar pulses.

Press the [TX] key to transmit. Echoes appear in four levels of digitized video according to echo strength. Note that when a target is beneath a marker (VRM, EBL, heading marker, range ring) the part of the marker where the target lies is displayed in reverse video.

Note: If you press the [TX] key before the indication ST-BY appears, the buzzer sounds and the radar does not transmit pulses.

When you won't be using the radar for an extended period, but you want to keep it in a state of readiness, press the [TX] key to set the radar in stand-by.

1.5 LCD Tone and Brilliance

1. Press the [TONE] key. The dialogue shown in Figure 1-3 appears.

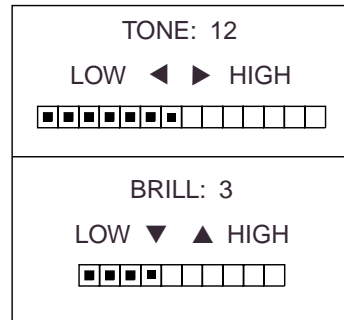

Figure 1-3 Dialogue for adjustment of LCD tone and brilliance

2. Press ◀ or ▶ or the [TONE] key to adjust tone; ▲ or ▼ to adjust brilliance.

The dialogue for adjustment of tone and brilliance is automatically erased when there is no TrackDisk operation for about 10 seconds. To erase it more quickly, press the [TONE] key after making the adjustment.

1.6 Selecting the Range

The range selected automatically determines the range ring interval, the number of range rings and pulse repetition rate.

Press the [+] or [-] key to select a range. The range and range ring interval appear at the top left corner on the screen.

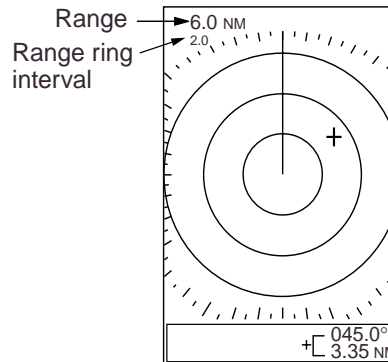

Figure 1-4 Location of range and range ring interval indications

1.7 Receiver Sensitivity

The [GAIN] key adjusts the sensitivity of the receiver. It works in precisely the same manner as the volume control of a broadcast receiver, amplifying the signals received.

You can adjust the sensitivity manually, or let the unit do it automatically. In either case, the proper setting is such that the background noise is just visible on the screen. Adjust the sensitivity on the highest range since the background noise is clearer on that range.

If you set up for too little sensitivity, weak echoes may be missed. On the other hand excessive sensitivity yields too much background noise; weak targets may be missed because of the poor contrast between desired echoes and the background noise on the display.

Automatic adjustment of sensitivity

1. Press the [GAIN] key once or twice to display the screen shown in Figure 1-5.

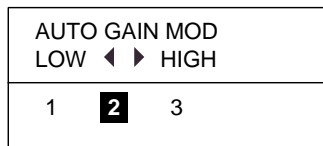

Figure 1-5 Dialogue for automatic adjustment of gain

2. Press ◀ or ▶ to set level desired: 1, Low; 2, Normal; 3, High.

Manual adjustment of sensitivity

1. Transmit the radar on long range.

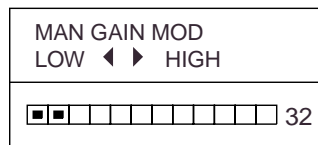

Figure 1-6 Dialogue for manual adjustment of gain

2. Press the [GAIN] key once or twice to display the screen shown in Figure 1-6.
3. Press ◀ or ▶ to set level desired. 61 levels are available.

Note: The dialogues for adjusting sensitivity are automatically erased when there is no TrackDisk operation for 10 seconds. To erase them quicker, press the [GAIN] key after completing the setting.

1.8 Suppressing Sea Clutter

In rough weather, returns from the sea surface are received over several miles around own ship and mask nearby targets. This situation can be improved by properly using the [STC] key.

If the setting is too low, targets will be hidden in the clutter, while if it is set too high, both sea clutter and targets will disappear from the display. In most cases adjust the key until clutter has disappeared to leeward, but a little is still visible windward.

A common mistake is to over-adjust the [STC] key so that the surface clutter is completely removed. By setting up for maximum STC effect, you will see how dangerous this can be; a dark zone will be created near the center of the screen, causing a loss of close-in targets. This dark zone is even more dangerous if the sensitivity has not been properly adjusted. Always leave a little surface clutter visible on the screen. If no clutter is observed (on very calm waters), turn off the circuit.

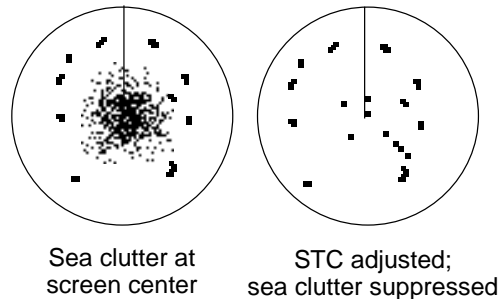

Figure 1-7 Appearance of sea clutter

Automatic sea clutter control

1. Press the [STC] key once or twice to show the dialogue shown in Figure 1-8.

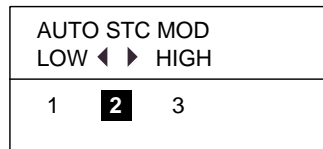

Figure 1-8 Dialogue for automatic adjustment of STC

2. Press ◀ or ▶ to set level desired: 1, Low; 2, Normal; 3, High.

Manual adjustment of sea clutter control

1. Press the [STC] key once or twice to display the dialogue shown in Figure 1-9.

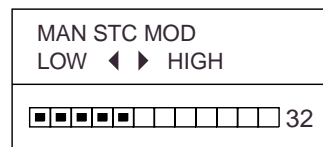

Figure 1-9 Dialogue for manual adjustment of STC

2. Press ◀ or ▶ to set level desired. 61 levels are available.

Note: The dialogues for adjusting STC are automatically erased when there is no TrackDisk operation for 10 seconds. To erase them quicker, press the [STC] key after completing the setting.

1.9 Suppressing Rain Clutter

In adverse weather, clouds, rain or snow produce spray-like spurious echoes which impair target detection over a long distance. These echoes can be suppressed by turning on the [FTC] key. FTC appears at the top right corner on the screen when the FTC circuit is on.

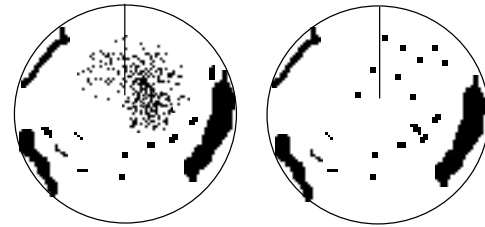

Figure 1-10 Appearance of rain clutter

1.10 Range Rings

The range rings are the concentric circles around own ship and they provide an estimated of target range. The selected range scale automatically determines the number of rings and their interval is displayed at the upper-left corner on the screen.

To turn the range rings on or off, press the [EBL] and [VRM] keys together.

1.11 Cursor

The cursor is always displayed and functions to measure the range and bearing to a target. Operate the TrackDisk to place the cursor on the inside edge of the target for range or center of the target for bearing. The range and bearing to the cursor appear at the bottom right corner on the display.

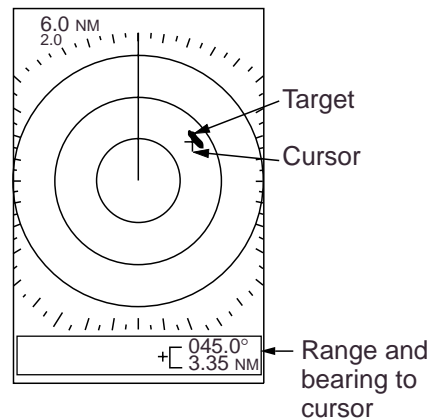

Figure 1-11 How to measure range and bearing with the cursor

1.12 Heading Marker

The heading marker indicates the ship's heading and it is the solid line which appears at zero degrees on the bearing scale.

To temporarily erase the heading marker to look at targets existing dead ahead of own ship, press the [MENU] and [GUARD] keys together. Release the keys to display the marker again.

1.13 Menu Operation

The menu contains ten functions which normally do not require frequent adjustment in everyday operation. Basic menu operation is as below.

Basic menu operation

1. Press the [MENU] key to display the menu.

PRESS ▼/▲ TO SELECT MENU ITEM, ◀/▶ TO CHANGE SETTING.		
1	ECHO STRETCH	ON OFF
2	INT. REJECT	ON OFF
3	NAV DATA	ON OFF
4	VIDEO	RVS NOM
5	WATCHMAN	OFF 5M 10M 20M
6	DIMMER	0 1 2 3

Press ▲ or ▼ at page boundaries to switch between menus.

PRESS ▼/▲ TO SELECT MENU ITEM, ◀/▶ TO CHANGE SETTING.		
7	DSPL ON STBY	NAV OFF
8	TRAIL TIME	CONT 30S 1M 3M 6M
9	TRAIL BRILL	LOW HIGH
10	RANGE (NM)	1/8 1/4 1/2 3/4 1 1.5 2 3 4 6 8 12 16

Default settings in highlight.

Figure 1-12 Menus

2. Press ▲ or ▼ to select item.
3. Press ◀ or ▶ to select option.
4. Press the [MENU] key to register option and close the menu.

Table 1-1 Menu description

Menu Item		Description
1	ECHO STRETCH	Stretches echoes in the range direction.
2	INT. REJECT	Suppresses radar interference.
3	NAV DATA	Turns navigation data on/off.
4	VIDEO	Displays echoes in black or white.
5	WATCHMAN	Selects transmitting interval.
6	DIMMER	Adjusts control panel brilliance.
7	DSPL ON STBY	Turns navigation data display in standby on/off.
8	TRAIL TIME	Select trail time (target echo plotting interval).
9	TRAIL BRILL	Selects echo trail brilliance.
10	RANGE	Selects range to use.

1.14 Control Panel Brilliance

1. Press the [MENU] key.
2. Select DIMMER.
3. Select level desired; 3 is the highest level of illumination.
4. Press the [MENU] key.

1.15 Measuring the Range

The bearing to a target can be measured by the range rings, by the cursor and by the VRM (Variable Range Marker).

Measuring range by the range rings

Count the number of rings between the center of the display and the target. Check the range ring interval and judge the distance of the echo from the inner edge of the nearest ring.

Measuring range by VRM

1. Press the [VRM] key to turn on the VRM.
2. Within 10 seconds after turning on the VRM; that is, while "VRM" is highlighted, press ▲ or ▼ to place the VRM on the inside edge of the target.
3. Check the VRM readout at the bottom left corner on the screen.

To erase the VRM, press and hold down the [VRM] key until the VRM disappears.

Note: The VRM is "frozen" on the display when the [VRM] key is pressed a second time, or 10 seconds elapses without pressing ▲ or ▼. When the VRM is fixed on the screen "VRM" is not highlighted.

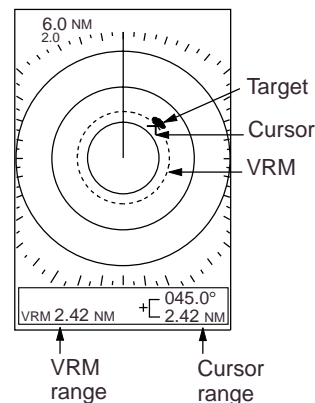

Figure 1-13 How to measure range by the cursor and VRM

1.16 Measuring the Bearing

The bearing to a target can be measured by using the cursor or the EBL.

Measuring bearing by the EBL

1. Press the [EBL] key to turn on the EBL.
2. Within 10 seconds after turning on the EBL; that is, while "EBL" is highlighted, press ◀ or ▶ to bisect the target with EBL.
3. Check the EBL readout at the bottom left corner on the screen.

To erase the EBL, press and hold down the [EBL] key until the EBL disappears.

Note: The EBL is "frozen" on the screen when the [EBL] key is pressed a second time, or 10 seconds elapses without pressing ◀ or ▶. When the EBL is fixed on the screen "EBL" is not highlighted.

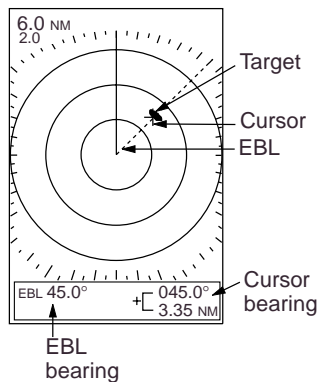

Figure 1-14 Measuring bearing by the cursor and the EBL

1.17 Shifting the Display

Your vessel's position can be shifted backward by 1/3 of the range to increase the forward range without changing the range or size of targets.

Press the [SHIFT] key to turn the shifted display on/off.

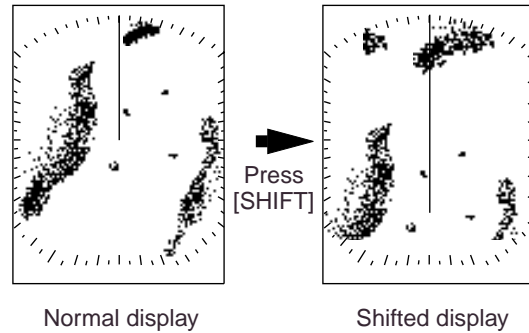

Figure 1-15 Shifting the display

1.18 Zoom

The zoom feature allows you to double the size of the area between your vessel and any location within the current range to take a closer look at an area of interest.

1. Select location with the cursor.
2. Press the [ZOOM] key.

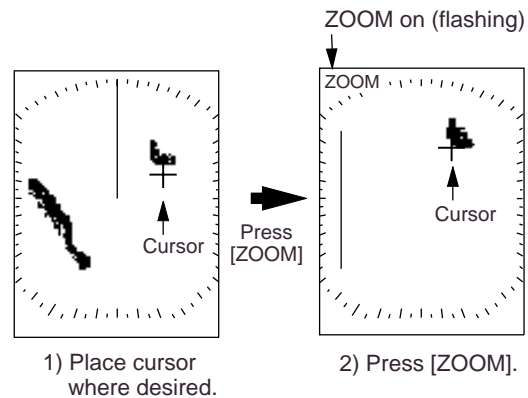

Figure 1-16 Zoom function

3. To turn off the zoom function, press the [ZOOM] key again.

Note 1: The zoom feature is inoperative when the display is shifted.

Note 2: Zoom function is not available on 0.125 (1/8) nm range.

1.19 Target Trails

Target trails are simulated afterglow of target echoes that represent their movements relative to own ship.

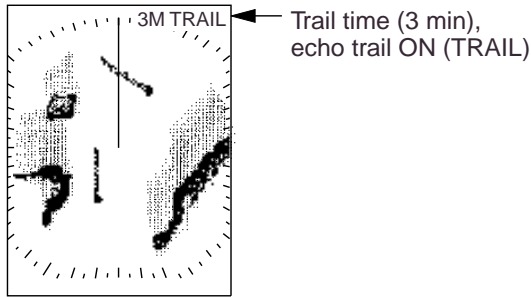

Figure 1-17 Target trails

Starting target trail

Press the [TRAIL] key to start the echo trail function. "TRAIL" and the target trail time selected appear at the top right corner on the screen. Then, afterglow starts extending from all targets.

Canceling target trail

Press the [TRAIL] key to erase target trails and target trail indications.

Trail time

1. Press the [MENU] key.
2. Select TRAIL TIME (on page 2 of the menu).
3. Select target trail time desired; continuous, 30 seconds, 1, 3 or 6 min as appropriate.
4. Press the [MENU] key.

Trail brilliance

1. Press the [MENU] key.
2. Select TRAIL BRILL (on page 2 of the menu).
3. Select HIGH or LOW as appropriate.
4. Press the [MENU] key.

1.20 Guard Alarm Zone

The guard alarm allows the operator to set the desired range and bearing for a guard zone. When ships, islands, landmasses, etc. violate the guard zone an audible alarm sounds to call the operator's attention. The alarm will sound on targets entering or exiting the zone depending on zone status after setting the alarm.

CAUTION

- * The alarm should not be relied upon as the sole means for detecting possible collision situations.
- * STC, FTC and GAIN controls should be properly adjusted to be sure the alarm system does not overlook target echoes.

How guard zone type is determined

After the guard zone is set, the radar starts searching for targets inside the guard zone for about 8 to 12 seconds. When it finishes searching it displays the results of the search as G (IN) or G (OUT), at the top right corner on the screen.

G (IN): When no target exists in the zone, "G (IN)" appears. The audible alarm sounds to targets which enter the guard zone.

G (OUT): When there are targets in the guard zone, the screen shows "G (OUT)". The audible alarm sounds on all targets which exist in the guard zone.

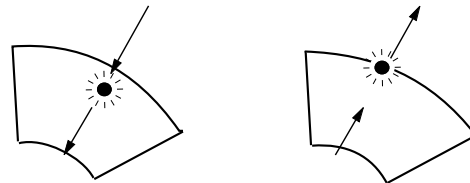

(a) Inward target alarm (b) Outward target alarm

Figure 1-18 Inward and outward alarms

Setting a guard zone

1. Operate the TrackDisk to place the cursor at the top left corner of the zone and press the [GUARD] key.
2. Operate the TrackDisk to place the cursor at the bottom right corner of the zone and press the [GUARD] key.

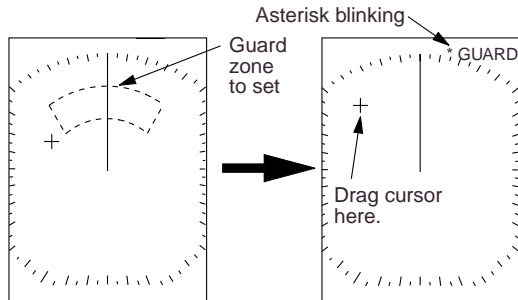

Mentally create the guard zone to set.

- 1) Drag cursor to top left corner of zone and press [GUARD].

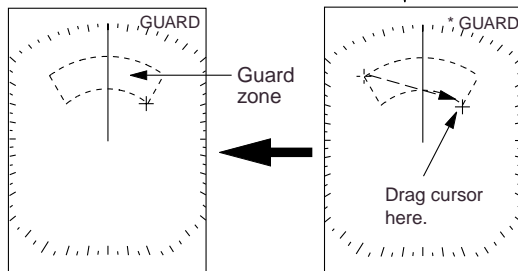

Guard zone completed.

- 2) Drag cursor to bottom right corner of zone and press [GUARD].

Figure 1-19 How to set a guard zone

3. About 10 seconds later "GUARD" replace G(IN) or G(OUT).

Note: When the radar range is less than one half of the guard zone range, the guard zone disappears and the indication "UP RNG" replaces G (IN) or G (OUT). If this happens, raise the range to redisplay the guard zone.

Silencing the audible alarm

When a target violates the guard zone, the target flashes and the audible alarm sounds. You can silence the audible alarm by pressing the [GUARD] key. When this is done, GUARD, displayed in reverse video, replaces G (IN) or G (OUT) and the guard zone is displayed in reverse video. This means the audible alarm is temporarily deactivated. Press the key again to reactivate the alarm.

Canceling the guard zone and guard alarm

Press and hold down the [GUARD] key more than two seconds to erase the guard zone.

1.21 Interference Rejector

Mutual radar interference may occur in the vicinity of another shipborne radar operating in the same frequency band (9 GHz). It is seen on the screen as a number of bright spikes either in irregular patterns or in the form of usually curved spoke-like dotted lines extending from the center to the edge of the picture. This type of interference can be reduced by activating the interference rejector circuit. "IR" appears at the top right corner when the interference rejector circuit is on.

1. Press the [MENU] key.
2. Select INT REJECT.
3. Select ON or OFF.
4. Press the [MENU] key.

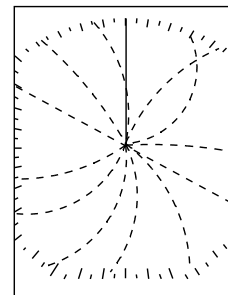

Figure 1-20 Radar interference

1.22 Echo Stretch

On long ranges target echoes tend to shrink in the range direction, making them difficult to see. On short and medium ranges such as 1.5, 3 and 6 nm range scales, the same sized targets get smaller on screen as they approach own ship. This is due to the inherent property of the radiation pattern produced by the antenna. To enhance target video, use the echo stretch feature.

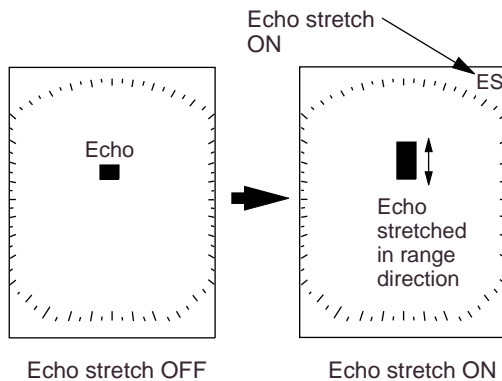

Figure 1-21 Echo stretch

1. Press the [MENU] key.
2. Select ECHO STRETCH.
3. Select ON or OFF.
4. Press the [MENU] key.

ES appears at the top right corner on the screen when the echo stretch feature is on.

Note 1: Echo stretch magnifies not only small target pips but also returns from sea surface, rain and radar interference. For this reason, make sure that these types of interference have been sufficiently suppressed before activating the echo stretch feature.

Note 2: Echo stretch is not available on the ranges between 0.125 and 0.75 nautical miles.

1.23 Watchman

The watchman function periodically transmits the radar for about one minute to check for targets in a guard zone. If it finds change in the zone from the previous transmission it sounds the audible alarm, cancels the watchman function and transmits the radar continuously. This feature is useful when you do not need to observe the radar continuously but want to be alerted to radar targets in a specific area, namely, the guard zone. When the radar starts transmitting, the buzzer sounds to alert the operator

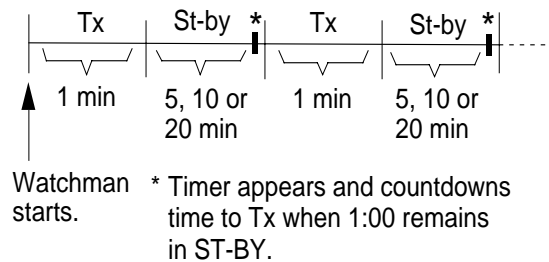

Figure 1-22 How watchman works

Turning watchman on/off

1. Set a guard zone.
2. Press the [MENU] key.
3. Select WATCHMAN.
4. Select transmitting interval, or turn watchman off as appropriate.
5. Press the [MENU] key.

"WATCHMAN" appears at the top left corner on the screen when the watchman function is on.

Note: If no guard zone is set, the buzzer sounds when the radar starts transmitting to alert the operator.

Canceling watchman

Press any key at any time. If done while transmitting, watchman is disabled and the normal display appears. In stand-by, the timer appears and counts down from one minute, and then the radar goes into stand-by.

1.24 Navigation Data

With navigation data input in NMEA 0183 format, navigation data can be displayed at the screen bottom.

Navigation data includes position, course, speed, and range and bearing to destination waypoint (if set on navaid).

Waypoint is shown on the screen by a "lollipop mark," a dashed ring which is connected to the screen center (own position) by a dashed line. You may turn it off or on by pressing [FTC] and [SHIFT] together.

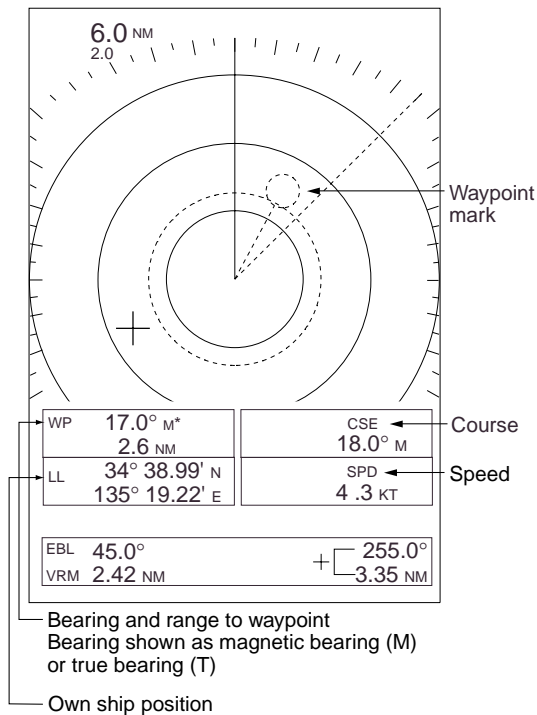

Figure 1-23 Sample navigation data display

Turning on the navigation data display

1. Press the [MENU] key.
2. Select NAV DATA.
3. Select ON.
4. Press the [MENU] key.

1.25 Displaying Navigation Data During Stand-by

Navigation data may be displayed during stand-by (requires external sensors) as follows:

1. Press the [MENU] key.
2. Select DSPL ON STBY.
3. Select NAV.
4. Press the [MENU] key

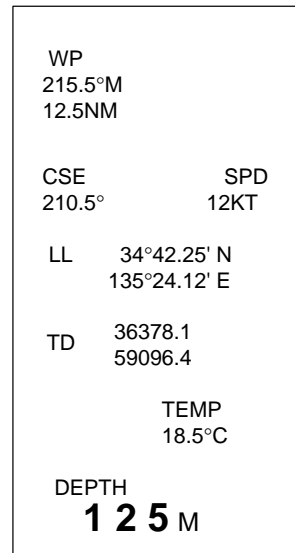

Figure 1-24 Sample navigation data screen shown during stand-by

Note: Nav data can be accepted from two sources: navigator and video sounder. When two of the same type of equipment is outputting data and it is not the same, the two sets of data are alternately displayed automatically.

Unit of measurement for depth and water temperature

The unit of measurement for depth and water temperature (external sensor required) can be selected with the [EBL] key in the sequence of Meters/Centigrade, Feet/Fahrenheit, Fathoms/Centigrade. See notes on next page for further information.

Note 1: External sensor must be capable of outputting such data to select it on this radar.

Note 2: A location is blank when there is no corresponding data.

Note 3: To receive data from multiple equipment, all data must be combined into one data line with a data-mixing device.

1.26 Echoes in Black or White

The default setting displays echoes in black on a white background. However, you may reverse this arrangement as shown below. Note that the default setting, echoes in black, is restored when the power is turned off.

1. Press the [MENU] key.
2. Select VIDEO.
3. Select RVS.
4. Press the [MENU] key.

1.27 Selecting Ranges to Use

This radar has 13 ranges, some you may not require. You can select the ranges to use as follows:

1. Press the [MENU] key.
2. Select RANGE (on page 2 of the menu).
3. Select range to use and press the [EBL] key.
4. Press the [MENU] key.

2. RADAR OBSERVATION

2.1 General

Minimum and maximum ranges

Minimum range

The minimum range is defined by the shortest distance at which, using a scale of 1.5 or 0.75 nm, a target having an echoing area of 10 m² is still shown separate from the point representing the antenna position.

It is mainly dependent on the pulselength, antenna height, and signal processing such as main bang suppression and digital quantization. It is a good practice to use a shorter range scale as far as it gives favorable definition or clarity of picture.

Maximum range

The maximum detecting range of the radar, R_{max}, varies considerably depending on several factors such as the height of the antenna above the waterline, the height of the target above the sea, the size, shape and material of the target, and the atmospheric conditions.

Under normal atmospheric conditions, the maximum range is equal to the radar horizon or a little shorter. The radar horizon is longer than the optical one by about 6% because of the diffraction property of the radar signal. The R_{max} is given in the following equation.

$$R_{\max} = 2.2 \times (\sqrt{h_1} + \sqrt{h_2})$$

where R_{max}: radar horizon (nautical miles)

h₁: antenna height (m)

h₂: target height (m)

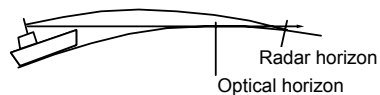

Figure 2-1 Radar horizon

For example, if the height of the antenna above the waterline is 9 meters and the height of the target is 16 meters, the maximum radar range is;

$$R_{\max} = 2.2 \times (\sqrt{9} + \sqrt{16}) = 2.2 \times (3 + 4) = 15.4 \text{ nmi}$$

It should be noted that the detection range is reduced by precipitation (which absorbs the radar signal).

Radar resolution

There are two important factors in radar resolution (discrimination): bearing resolution and range resolution.

Bearing resolution

Bearing resolution is the ability of the radar to display as separate pips the echoes received from two targets which are at the same range and close together. It is proportional to the antenna length and reciprocally proportional to the wavelength. The length of the antenna radiator should be chosen for a bearing resolution better than 2.5 degrees.

Range resolution

Range resolution is the ability to display as separate pips the echoes received from two targets which are on the same bearing and close to each other. This is determined by pulselength only. Practically, a 0.08 microsecond pulse offers the discrimination better than 35 m as do so with all FURUNO radars.

Test targets for determining the range and bearing resolution are radar reflectors having an echoing area of 10 m².

Bearing accuracy

One of the most important features of the radar is how accurately the bearing of a target can be measured. The accuracy of bearing measurement basically depends on the narrowness of the radar beam. However, the bearing is usually taken relative to the ship's heading, and thus, proper adjustment of the heading line at installation is an important factor in ensuring bearing accuracy. To minimize error when measuring the bearing of a target, put the target echo at the extreme position on the screen by selecting a suitable range.

Range measurement

Measurement of the range to a target is also a very important function of the radar. Generally, there are two means of measuring range: the fixed range rings and the variable range marker (VRM). The fixed range rings appear on the screen with a predetermined interval and provide a rough estimate of the range to a target. The variable range marker's diameter is increased or decreased so that the marker touches the inner edge of the target, allowing the operator to obtain more accurate range measurements.

2.2 False Echoes

Occasionally echo signals appear on the screen at positions where there is no target or disappear even if there are targets. They are, however, recognized if you understand the reason why they are

displayed. Typical false echoes are shown below.

Multiple echoes

Multiple echoes occur when a transmitted pulse returns from a solid object like a large ship, bridge, or breakwater. A second, a third or more echoes may be observed on the display at double, triple or other multiples of the actual range of the target as shown below. Multiple reflection echoes can be reduced and often removed by decreasing the gain (sensitivity) or properly adjusting the [STC] control.

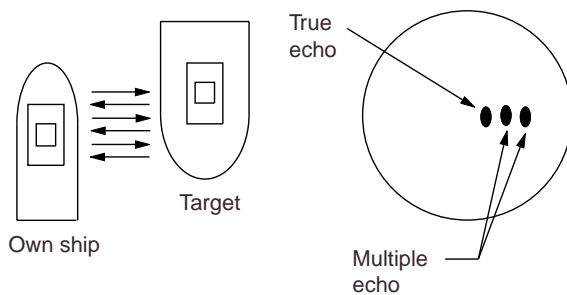

Figure 2-2 Multiple echoes

Sidelobe echoes

Every time the radar pulse is transmitted, some radiation escapes on each side of the beam, called sidelobes. If a target exists where it can be detected by the side lobes as well as the main lobe, the side echoes may be represented on both sides of the true echo at the same range. Sidelobes show usually only on short ranges and from strong targets. They can be reduced through careful reduction of the gain or proper adjustment of the [STC] control.

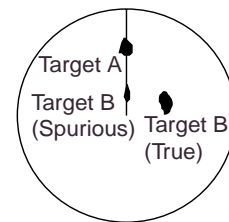

Figure 2-3 Sidelobe echoes

Virtual image

A relatively large target close to your ship may be represented at two positions on the screen. One of them is the true echo directly reflected by the target and the other is a false echo which is caused by the mirror effect of a large object on or

close to your ship as shown in the figure below. If your ship comes close to a large metal bridge, for example, such a false echo may temporarily be seen on the screen.

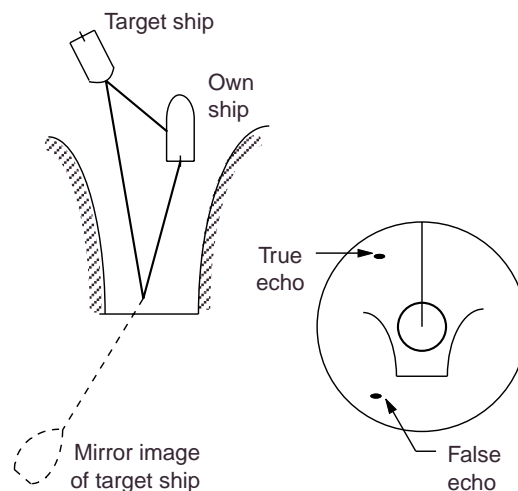

Figure 2-4 Virtual image

Shadow sectors

Funnels, stacks, masts, or derricks in the path of the antenna block the radar beam. If the angle subtended at the antenna is more than a few degrees, a non-detecting sector may be produced. Within this sector targets can not be detected.

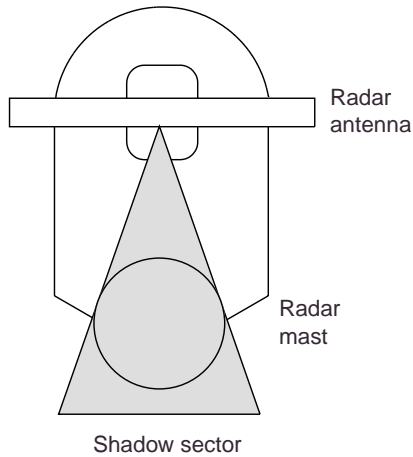

Figure 2-5 Shadow sectors

2.3 SART (Search and Rescue Transponder)

Note: The SART information below is excerpted from IMO SN/Circ 197 Operation of Marine Radar for SART Detection.

A Search and Rescue Transponder (SART) may be triggered by any X-Band (3 cm) radar within a range of approximately 8 nm. Each radar pulse received causes it to transmit a response which is swept repetitively across the complete radar frequency band. When interrogated, it first sweeps rapidly ($0.4 \mu\text{s}$) through the band before beginning a relatively slow sweep ($7.5 \mu\text{s}$) through the band back to the starting frequency. This process is repeated for a total of twelve complete cycles. At some point in each sweep, the SART frequency will match that of the interrogating radar and be within the pass band of the radar receiver. If the SART is within range, the frequency match during each of the 12 slow sweeps will produce a response on the radar display, thus a line of 12 dots equally spaced by about 0.64 nautical miles will be shown.

When the range to the SART is reduced to about 1 nm, the radar display may show also the 12 responses generated during the fast sweeps. These additional dot responses, which also are equally spaced by 0.64 nm, will be interspersed with the original line of 12 dots. They will appear slightly weaker and smaller than the original dots.

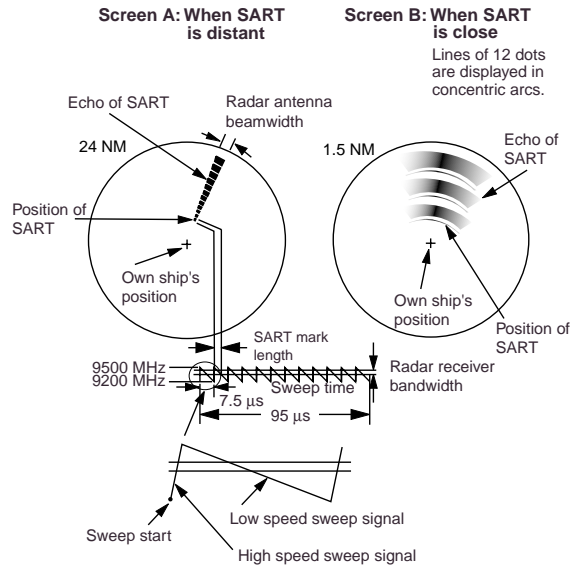

Figure 2-6 Appearance of SART signal on the radar display

General procedure for detecting SART response

1. Use the range scale of 6 or 12 nm as the spacing between the SART responses is about 0.6 nm (1125 m) to distinguish the SART.
2. Turn off the automatic clutter suppression.
3. Turn off the Interference Rejector.

General remarks on receiving SART

SART range errors

When responses from only the 12 low frequency sweeps are visible (when the SART is at a range greater than about 1 nm), the position at which the first dot is displayed may be as much as 0.64 nm beyond the true position of the SART. When the range closes so that the fast sweep responses are seen also, the first of these will be no more than 150 meters beyond the true position.

Radar bandwidth

This is normally matched to the radar pulselength and is usually switched with the range scale and the associated pulselength. Narrow bandwidths of 3-5 MHz are used with long pulses on long range and wide bandwidths of 10-25 MHz with short pulses on short ranges.

Any radar bandwidth of less than 5 MHz will attenuate the SART signal slightly, so it is preferable to use a medium bandwidth to ensure optimum detection of the SART.

Radar side lobes

As the SART is approached, sidelobes from the radar antenna may show the SART responses as a series of arcs or concentric rings. These can be removed by the use of the anti-clutter sea control although it may be operationally useful to observe the sidelobes as they may be easier to detect in clutter conditions and also they will confirm that the SART is near to the ship.

Gain

For maximum range SART detection the normal gain setting for long range detection should be used, that is, with background noise speckle visible.

STC control

For optimum range SART detection, this control should be set to the minimum. Care should be exercised as wanted target in sea clutter may be obscured. Note also that in clutter conditions the first few dots of the SART response may not be detectable, irrespective of the setting of the anti-clutter sea control. In this case, the position of the SART may be estimated by measuring 9.5 nm miles from the furthest dot back towards own ship.

Some sets have automatic/manual anti-clutter sea control facilities in which case the operator should switch to manual.

FTC control

This should be used normally (to break up areas of rain) when trying to detect a SART response which, being a series of dots, is not affected by the action of the anti-clutter rain circuitry. Note that Racon responses, which are often in the form of a long flash, will be affected by the use of this control.

Some sets have automatic/manual anti-clutter rain control facilities in which case the operator should switch to manual.

When the range to the SART is reduced to about 1 nm, the radar display may show also the 12 responses generated during the fast sweeps. These additional dot responses, which also are equally spaced by 0.64 nm, will be interspersed with the original line of 12 dots. They will appear slightly weaker and smaller than the original dots.

General procedure for detecting SART response

1. Use the range scale of 6 or 12 nm as the spacing between the SART responses is about 0.6 nm (1125 m) to distinguish the SART.
2. Turn off the automatic clutter suppression.
3. Turn off the Interference Rejector.

General remarks on receiving SART

SART range errors

When responses from only the 12 low frequency sweeps are visible (when the SART is at a range greater than about 1 nm), the position at which the first dot is displayed may be as much as 0.64 nm beyond the true position of the SART. When the range closes so that the fast sweep responses are seen also, the first of these will be no more than 150 meters beyond the true position.

Radar bandwidth

This is normally matched to the radar pulselength and is usually switched with the range scale and the associated pulselength. Narrow bandwidths of 3-5 MHz are used with long pulses on long range and wide bandwidths of 10-25 MHz with short pulses on short ranges.

Any radar bandwidth of less than 5 MHz will attenuate the SART signal slightly, so it is preferable to use a medium bandwidth to ensure optimum detection of the SART.

Radar side lobes

As the SART is approached, sidelobes from the radar antenna may show the SART responses as a series of arcs or concentric rings. These can be removed by the use of the anti-clutter sea control although it may be operationally useful to observe the sidelobes as they may be easier to detect in clutter conditions and also they will confirm that the SART is near to the ship.

Gain

For maximum range SART detection the normal gain setting for long range detection should be used, that is, with background noise speckle visible.

STC control

For optimum range SART detection, this control should be set to the minimum. Care should be exercised as wanted target in sea clutter may be obscured. Note also that in clutter conditions the first few dots of the SART response may not be detectable, irrespective of the setting of the anti-clutter sea control. In this case, the position of the SART may be estimated by measuring 9.5 nm miles from the furthest dot back towards own ship.

Some sets have automatic/manual anti-clutter sea control facilities in which case the operator should switch to manual.

FTC control

This should be used normally (to break up areas of rain) when trying to detect a SART response which, being a series of dots, is not affected by the action of the anti-clutter rain circuitry. Note that Racon responses, which are often in the form of a long flash, will be affected by the use of this control.

Some sets have automatic/manual anti-clutter rain control facilities in which case the operator should switch to manual.

2.4 Racon (Radar Beacon)

A racon is a radar transponder which emits a characteristic signal when triggered by a ship's radar (usually only the 3 centimeter band). The signal may be emitted on the same frequency as that of the triggering radar, in which case it is superimposed on the ship's radar display automatically.

The racon signal appears on the PPI as a radial line originating at a point just beyond the position of the radar beacon or as a Morse code signal (figure below) displayed radially from just beyond the beacon.

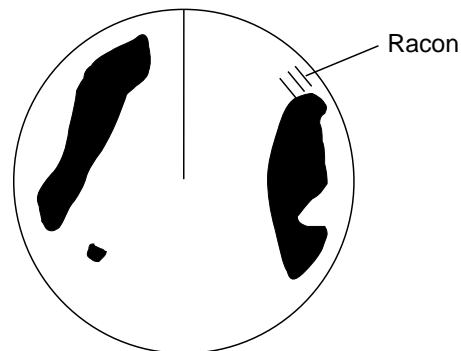

Figure 2-7 Appearance of Racon signal on the radar display

3. MAINTENANCE, TROUBLESHOOTING

3.1 Maintenance

Regular maintenance is important for good performance. A maintenance program should be established and should at least include the items listed in Table 3-1.

Table 3-1 Maintenance program

Period	Item	Check point	Action
3 to 6 months	Fixing bolts for antenna unit	Check for corrosion and if tightly fastened.	Replace corroded bolts. Coat new bolts with anticorrosive sealant.
	Antenna unit cleanliness	Check for foreign material. (Foreign material on the antenna unit can cause a considerable drop in sensitivity.)	Clean the antenna unit with a freshwater-moistened cloth. Alcohol may be used. Do not use commercial cleaners to clean the antenna unit; they can remove paint and markings.
	Antenna unit cover	Check for cracks. Permanent damage to the unit's circuitry will result if water leaks inside	If a crack is found, it should be temporarily repaired by using a small amount of sealing compound or adhesive. The unit should then be brought to your dealer for permanent repairs.
	LCD	The LCD will, in time, accumulate a coating of dust which tends to dim the picture.	Wipe the LCD gently with a soft cloth. Do not use commercial cleaners to clean the LCD; they can remove paint and markings.
6 months to 1 year	Display unit connectors	Check for tight connection and corrosion.	If corroded, see your dealer about replacement.

3.2 Replacing the Fuse

The fuse (5A) in the power cable protects the equipment against reverse polarity of ship's mains, overcurrent, and equipment fault. If the fuse blows, find the cause before replacing it. Never use a fuse rated for more than 5A, since overfusing can cause serious damage to the equipment and void the warranty.

3.3 Troubleshooting

Table 3-2 provides simple troubleshooting procedures which the user can follow to restore normal operation.

Table 3-2 Troubleshooting

If...	But...	Then...
you pressed the [POWER] key to turn on the radar	the control panel does not light	<ul style="list-style-type: none"> • adjust DIMMER on the menu. • battery may have discharged. • check if fuse has blown
	nothing appears on the display (panel lights) or display contrast is poor	try adjusting LCD tone.
the radar has warmed up and you pressed the [TX] key to transmit	“HD-SIG-MISSING” or “BP-SIG-MISSING” appears on the display (panel is lit) or display contrast is poor	check that the signal cable is tightly fastened.
you adjusted sensitivity (with the FTC switched OFF)	neither noise or targets appear (characters and markers do)	check signal cable for damage.
	neither indications or markers do (noise and targets do)	check signal cable for damage.
A key is pressed	nothing happens	key may be faulty. Contact your dealer.

3.4 Magnetron Replacement

When the magnetron has expired distant targets cannot be seen on the display. When you feel long range performance has decreased contact a FURUNO agent or dealer about replacement of the magnetron. Magnetron type: E3588, Code No: 000-142-270.

3.5 Synchro Belt Replacement

When the belt has worn out, the sweep is not synchronized with antenna rotation, which results in abnormal picture. When you suspect the synchro belt is worn, contact a FURUNO agent or dealer about. Synchro belt type: 40 S2M 266UG, Code No: 000-808-743.

SPECIFICATIONS OF MARINE RADAR MODEL 1622

1. GENERAL

(1) Indication System PPI Daylight display, raster scan, 4 tones in monochrome

(2) Range, Pulselength (PL) & Pulse Repetition Rate (PRR)

Range (nm)	0.125, 0.25, 0.5, 0.75	1, 1.5, 2	3, 4, 6, 8, 12, 16
Pulse Length	0.12 μ s (short)	0.3 μ s (medium)	0.8 μ s (long)
Pulse Repetition Rate	2100 Hz nominal	1200 Hz nominal	600 Hz nominal

(3) Range Resolution Better than 50 m

(4) Bearing Discrimination Within 7.7°

(5) Minimum Range 41 m

(6) Bearing Accuracy Within 1°

(7) Range Ring Accuracy 0.9 % of range or 8 m, whichever is the greater

2. SCANNER UNIT

(1) Radiator Micro-strip

(2) Polarization Horizontal

(3) Antenna Rotation Speed 24 rpm nominal

(4) Radiator Length 34 cm

(5) Horizontal Beamwidth Less than 6.2°

(6) Vertical Beamwidth 25°

(7) Sidelobe Attenuation Less than -20 dB

3. TRANSCEIVER MODULE

(1) Frequency 9410 MHz \pm 30MHz (X band)

(2) Modulation PON

(3) Peak Output Power 2.2 kW

(4) Modulator FET Switching Method

(5) Intermediate Frequency 60 MHz

(6) Tuning Automatic

(7) Receiver Front End MIC (Microwave IC)

(8) Bandwidth 7 MHz

(9) Duplexer Circulator with diode limiter

(10) Time of Heat-up 1-min. approx.

4. DISPLAY UNIT

- (1) Picture Tube 6 inch rectangular monochrome LCD
 (2) Display Pixels 240(H) x 320(V) dots, Effective radar display area: 240 x 240 dots

- (3) Range, Range Interval, Number of Rings

Range (NM)	0.125	0.25	0.5	0.75	1	1.5	2	3	4	6	8	12	16
Ring Interval (NM)	0.0625	0.125	0.125	0.25	0.25	0.5	0.5	1	1	2	2	3	4
Number of Rings	2	2	4	3	4	3	4	3	4	3	4	4	4

- (4) Markers Heading Line, Bearing Scale, Range Rings, Variable Range Marker (VRM), Electronic Bearing Line (EBL), Tuning Bar, Cursor, Parallel Cursor, Alarm Zone, Waypoint Mark (navigation input required), North Mark (heading sensor input required)
- (5) Alphanumeric Indications Range, Range Ring Interval, Display Mode (HU), Interference Rejection(IR), Variable Range Marker (VRM), Electronic Bearing Line (EBL), Stand-by (ST-BY), Guard Alarm (G(IN), G(OUT), UP RANGE), Echo Stretch (ES), Range and Bearing to Cursor, Bearing or L/L Position, Echo Tailing (TRAIL), Trailing Time, Trailing Elapsed Time, Watchman (WATCHMAN), Zoomed Display (ZOOM), Navigation Data (navigation input required), Heading (HDC, heading sensor input required)
- (6) Input Data NMEA0183 (Ver.1.5/2.0)
- Own ship's position: GGA>RMA>RMC> GLL
- Speed: RMA>RMC>VTG>VBW
- Heading (True): HDT>HDG^{*1}>HDM^{*1}
- Heading (Magnetic): HDM>HDG^{*1}>HDT^{*1}
- Course (True): RMA>RMC>VTG
- Course (Magnetic): VTG>RMA
- Waypoint(Range, Bearing): RMB>BWC>BWR
- Loran time difference: RMA>GLC>GTD
- Water depth: DPT >DBK>DBS>DBT
- Water temperature: MTW

*1: calculate by magnetic drift.

5. ENVIRONMENTAL CONDITION

- (1) Ambient Temperature Scanner Unit: -25°C to +70°C
 Display Unit: -15°C to +55°C
- (2) Relative Humidity 95 % or less at +40°C

- (3) Waterproofing
 - Scanner Unit IPX6
 - Display Unit IPX5
- (4) Bearing Vibration IEC60945

6. POWER SUPPLY

- (1) Power Supply 12/24 VDC: 3.2/1.3 A, 35 W approx. (Watchman: 8 W or less)

7. DIMENSIONS AND MASS

See the Outline Drawings

8. COATING COLOR

- (1) Display Unit
 - Panel: N3.0
 - Chassis: 2.5GY5/1.5
- (2) Scanner Unit
 - Cover: N9.5, Bottom: 2.5PB 3.5/10

9. COMPASS SAFE DISTANCE

- (1) Display Unit
 - Standard: 0.65 m
 - Steering: 0.50 m
- (2) Scanner Unit
 - Standard: 1.25 m
 - Steering: 0.95 m

INDEX

B	
Bearing measurement	8
C	
Control description	1
Cursor	5
D	
Depth unit	12
DIMMER key	7
E	
EBL (Electronic Bearing Line)	8
EBL key	8
Echo hue	13
Echo stretch	11
F	
False echoes	16
FTC	5
Fuse replacement	21
G	
GAIN key	4
Guard alarm	9
GUARD key	10
H	
Heading marker	6
I	
Indications	2
Interference rejector	10
M	
Magnetron replacement	22
Maintenance	21
Menu operation	6
Multiple echoes	16
N	
Nav data	12
P	
POWER key	3
R	
Range	
measurement	7
minimum and maximum	15
selection	3
Range measurement	7
Range rings	5
Ranges to use	13
S	
SART	17
Shadow sector	17
SHIFT key	8
Sidelobe echoes	16
STC key	4
Synchro belt replacement	22
T	
Target trails	9
TONE key	3
TRAIL key	9
Troubleshooting	22
TX key	3
V	
Virtual image	16
VRM (Variable Range Marker)	7
VRM key	7
W	
Watchman	11
Water temperature unit	12
Z	
ZOOM key	8

FURUNO

FURUNO ELECTRIC CO., LTD.

9-52 Ashihara-Cho, Nishinomiya City, 662-8580, Hyogo, Japan

Tel: +81 798-65-2111 Fax: +81 798-65-4200

Pub NO. DOC-287

Declaration of Conformity  **0560**

We **FURUNO ELECTRIC CO., LTD.**

(Manufacturer)

9-52 Ashihara-Cho, Nishinomiya City, 662-8580, Hyogo, Japan

(Address)

declare under our sole responsibility that the product

6" LCD Radar Model 1622 for recreational crafts
(Serial No. 3393-0002)

(Model name, serial number)

is in conformity with the essential requirements as described in the Directive 1999/5/EC of the European Parliament and of the Council of 9 March 1999 on radio equipment and telecommunications terminal equipment (R&TTE Directive) and satisfies all the technical regulations applicable to the product within this Directive

EN 60945: 1997-01 (IEC 945 Third edition: 1996-11)
KSR 142, Annex 1

(title and/or number and date of issue of the standard(s) or other normative document(s))

For assessment, see

- Statement of Opinion N° 00214114/AA/00 of 5 December 2000 issued by KTL Certification, The Netherlands
- Test report FLI 12-00-017 of July 16 2000 and FLI 12-00-019 of July 16 2000 prepared by Furuno Labotech International Co., Ltd.

On behalf of Furuno Electric Co., Ltd.

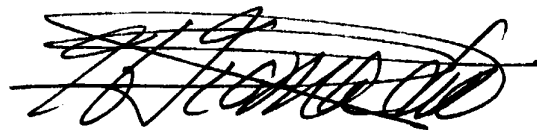

Hiroaki Komatsu
Manager,
International Rules and Regulations

Nishinomiya City, Japan
December 18, 2000

(Place and date of issue)

(name and signature or equivalent marking of authorized person)